

**Musterlösung**  
Name

**SB01**  
Inhalt

Datum

Maßstab

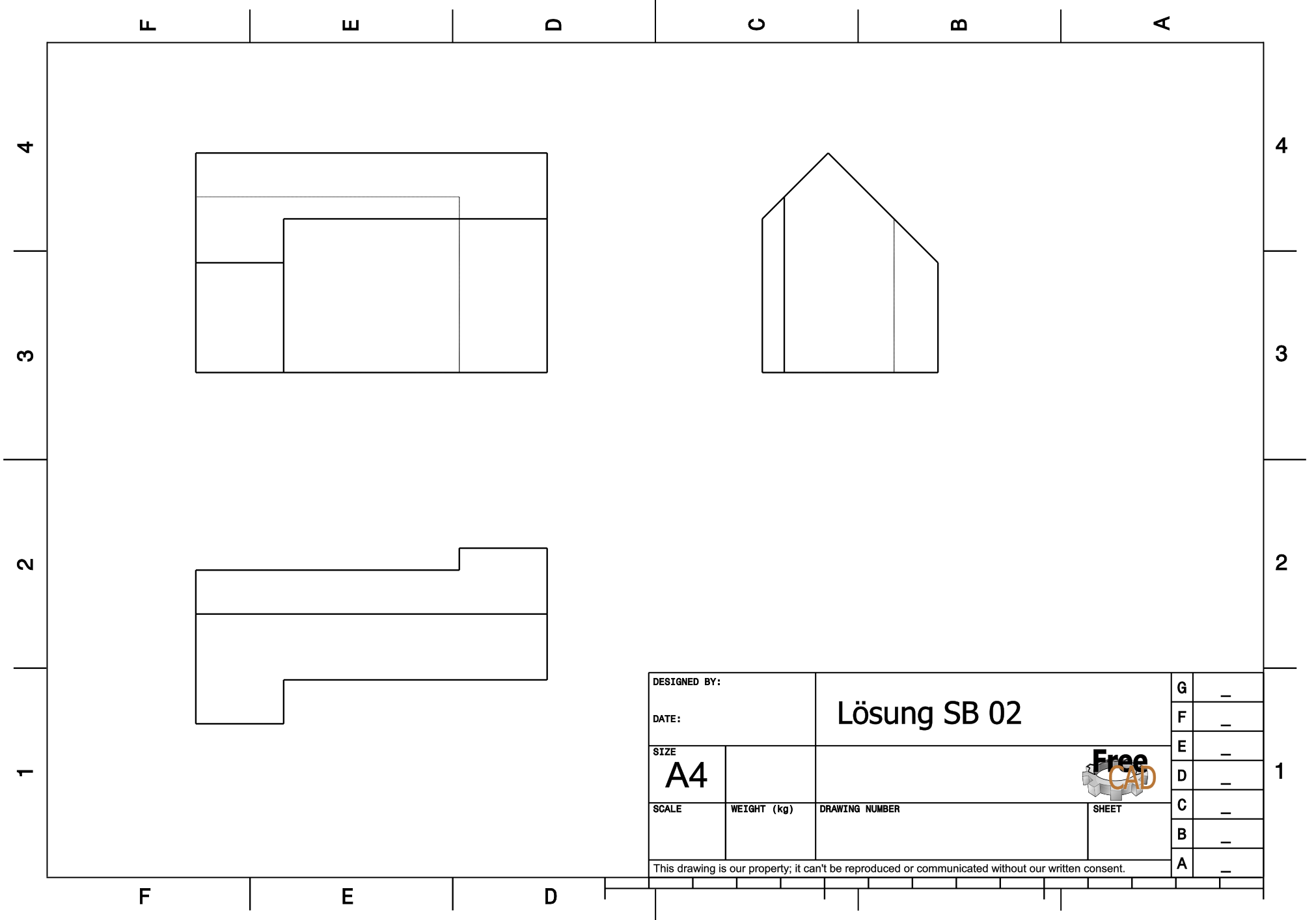

|   |             |                |       |   |   |
|---|-------------|----------------|-------|---|---|
| DESIGNED BY:  |             | Lösung SB 02   |       | G | - |
| DATE:   |             |                |       | F | - |
| SIZE  | A4          |                |       | E | - |
| SCALE   | WEIGHT (kg) | DRAWING NUMBER | SHEET | D | - |
|   |             |                |       | C | - |
|   |             |                |       | B | - |
| This drawing is our property; it can't be reproduced or communicated without our written consent. |             |                |       | A | - |



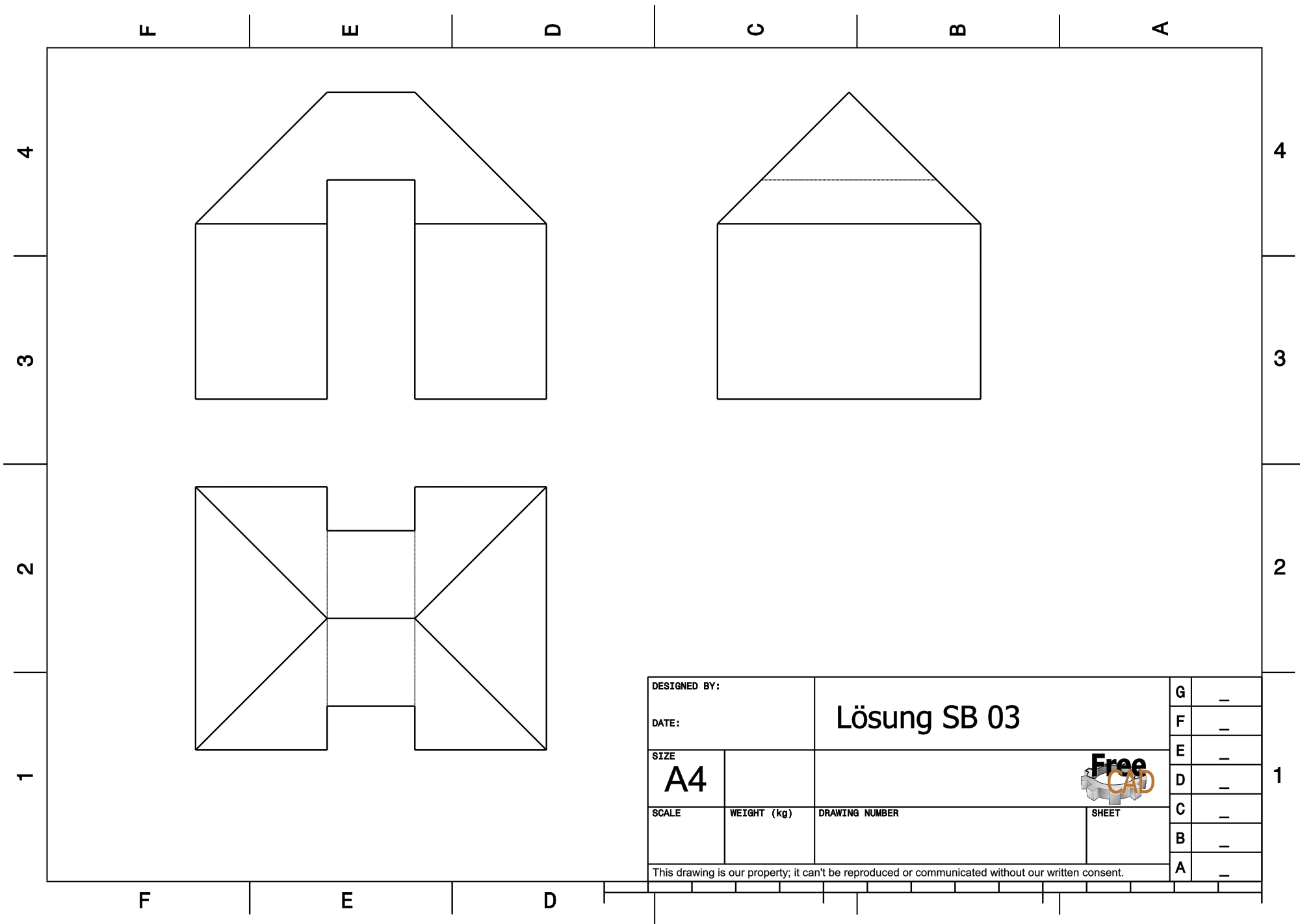

|              |                |              |   |   |   |
|--------------|----------------|--------------|---|---|---|
| DESIGNED BY: |                | Lösung SB 03 |   | G | - |
| DATE:        |                |              |   | F | - |
| SIZE         | A4             | Free<br>CAD  |   | E | - |
| SCALE        |                |              |   | D | - |
| WEIGHT (kg)  | DRAWING NUMBER | C            | - |   |   |
|              |                | B            | - |   |   |
|              |                | A            | - |   |   |

This drawing is our property; it can't be reproduced or communicated without our written consent.

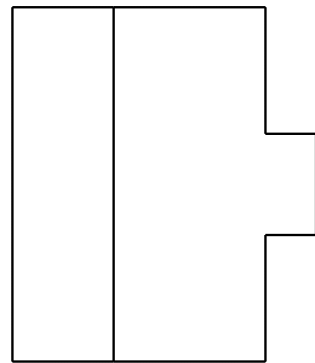
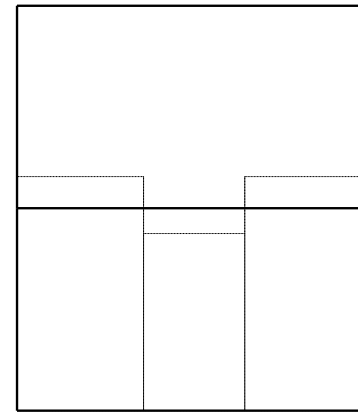
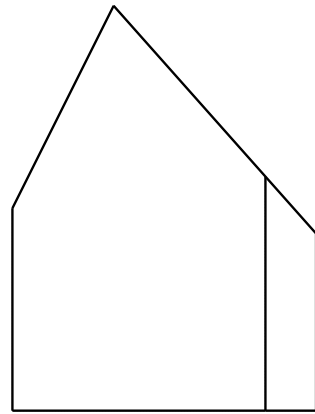

**Loesung**  
Name

**SB 04**  
Inhalt

Datum

Maßstab

F

E

D

C

B

A

4

4

3

3

2

2

1

1

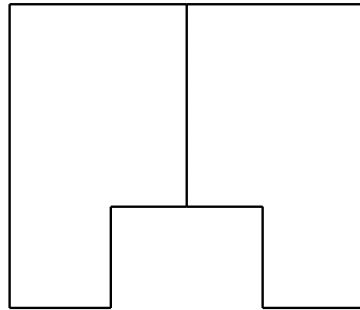
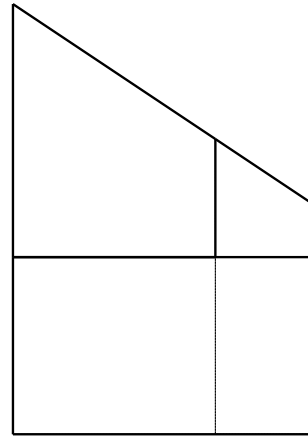
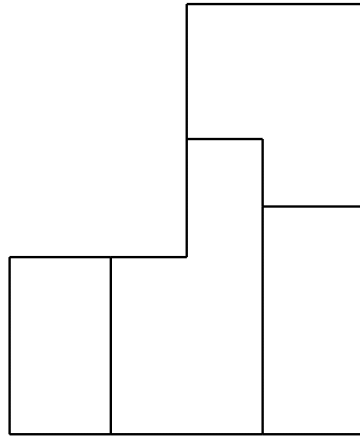

|   |             |                |       |   |   |
|---|-------------|----------------|-------|---|---|
| DESIGNED BY:  |             | SB 09          |       | G | - |
| DATE:   |             |                |       | F | - |
| SIZE  | A4          |                |       | E | - |
| SCALE   | WEIGHT (kg) | DRAWING NUMBER | SHEET | D | - |
|   |             |                |       | C | - |
|   |             |                |       | B | - |
| This drawing is our property; it can't be reproduced or communicated without our written consent. |             |                |       | A | - |



F

E

D

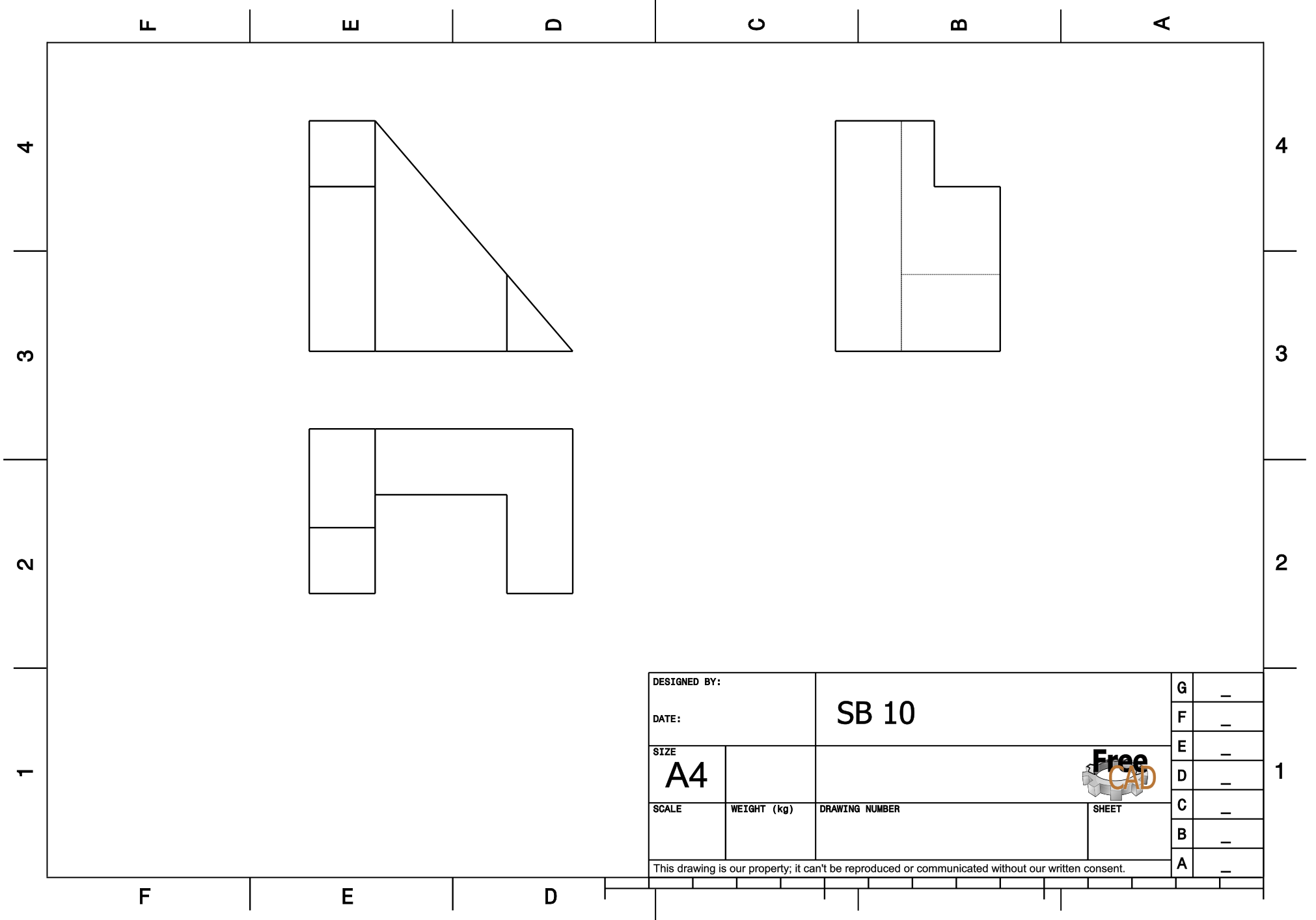

|   |             |                |       |   |   |
|---|-------------|----------------|-------|---|---|
| DESIGNED BY:  |             | SB 10          |       | G | - |
| DATE:   |             |                |       | F | - |
| SIZE  | A4          |                |       | E | - |
| SCALE   | WEIGHT (kg) | DRAWING NUMBER | SHEET | D | - |
|   |             |                |       | C | - |
|   |             |                |       | B | - |
| This drawing is our property; it can't be reproduced or communicated without our written consent. |             |                |       | A | - |



F E D C B A

4

3

2

1

4

3

2

1

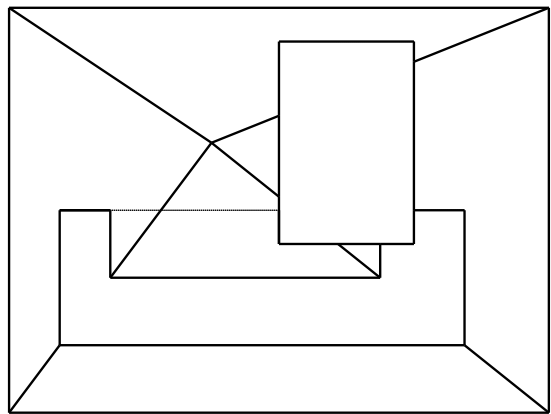
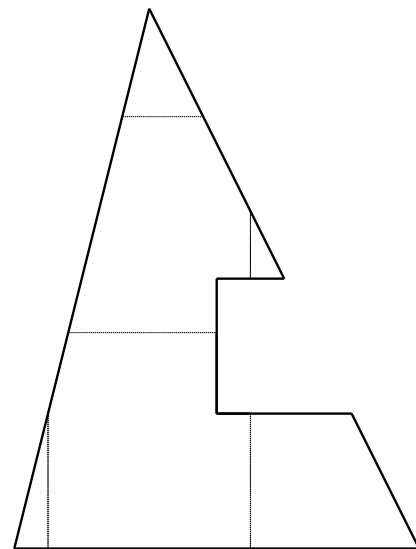
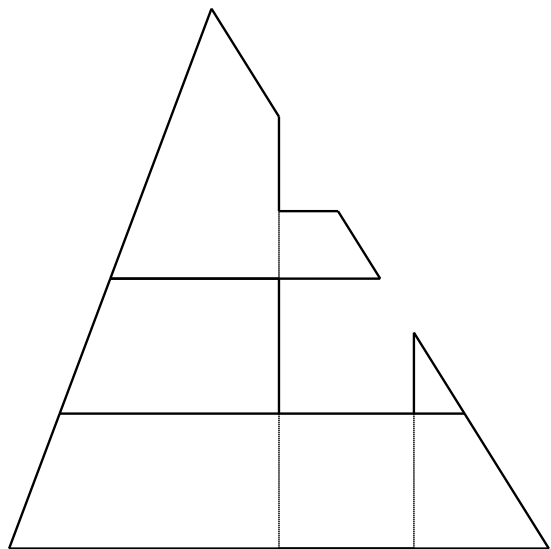

|              |             |                |       |   |   |
|--------------|-------------|----------------|-------|---|---|
| DESIGNED BY: |             | Lösung SB 14   |       | G | - |
| DATE:        |             |                |       | F | - |
| SIZE         | A4          |                |       | E | - |
| SCALE        | WEIGHT (kg) | DRAWING NUMBER | SHEET | D | - |
|              |             |                |       | C | - |
|              |             |                |       | B | - |
|              |             |                |       | A | - |



This drawing is our property; it can't be reproduced or communicated without our written consent.

F E D

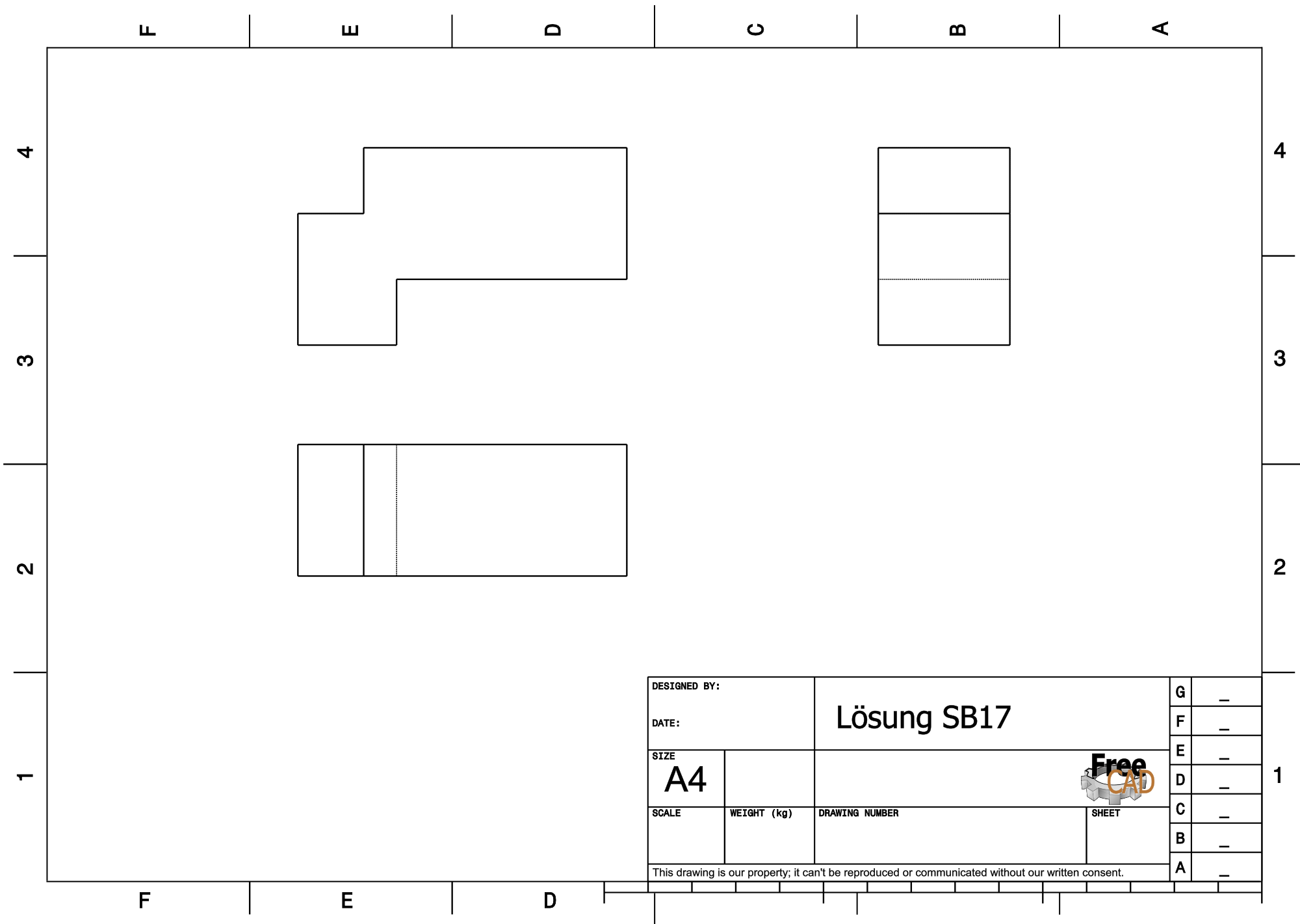

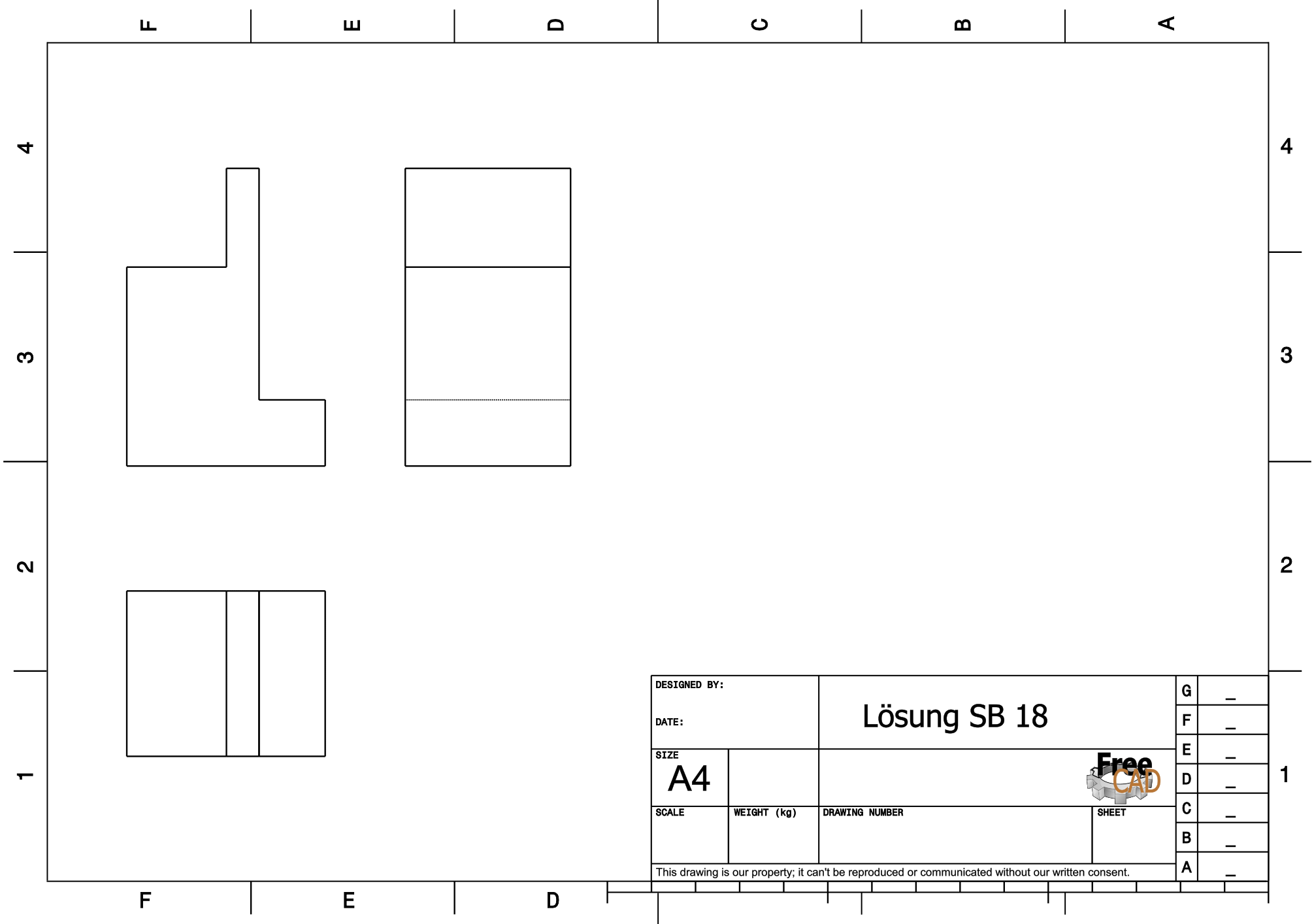

|              |                |             |   |   |   |
|--------------|----------------|-------------|---|---|---|
| DESIGNED BY: |                | Lösung SB17 |   | G | - |
| DATE:        |                |             |   | F | - |
| SIZE         | A4             | Free CAD    |   | E | - |
| SCALE        |                |             |   | D | - |
| WEIGHT (kg)  | DRAWING NUMBER | C           | - |   |   |
|              |                | B           | - |   |   |
|              |                | A           | - |   |   |

This drawing is our property; it can't be reproduced or communicated without our written consent.

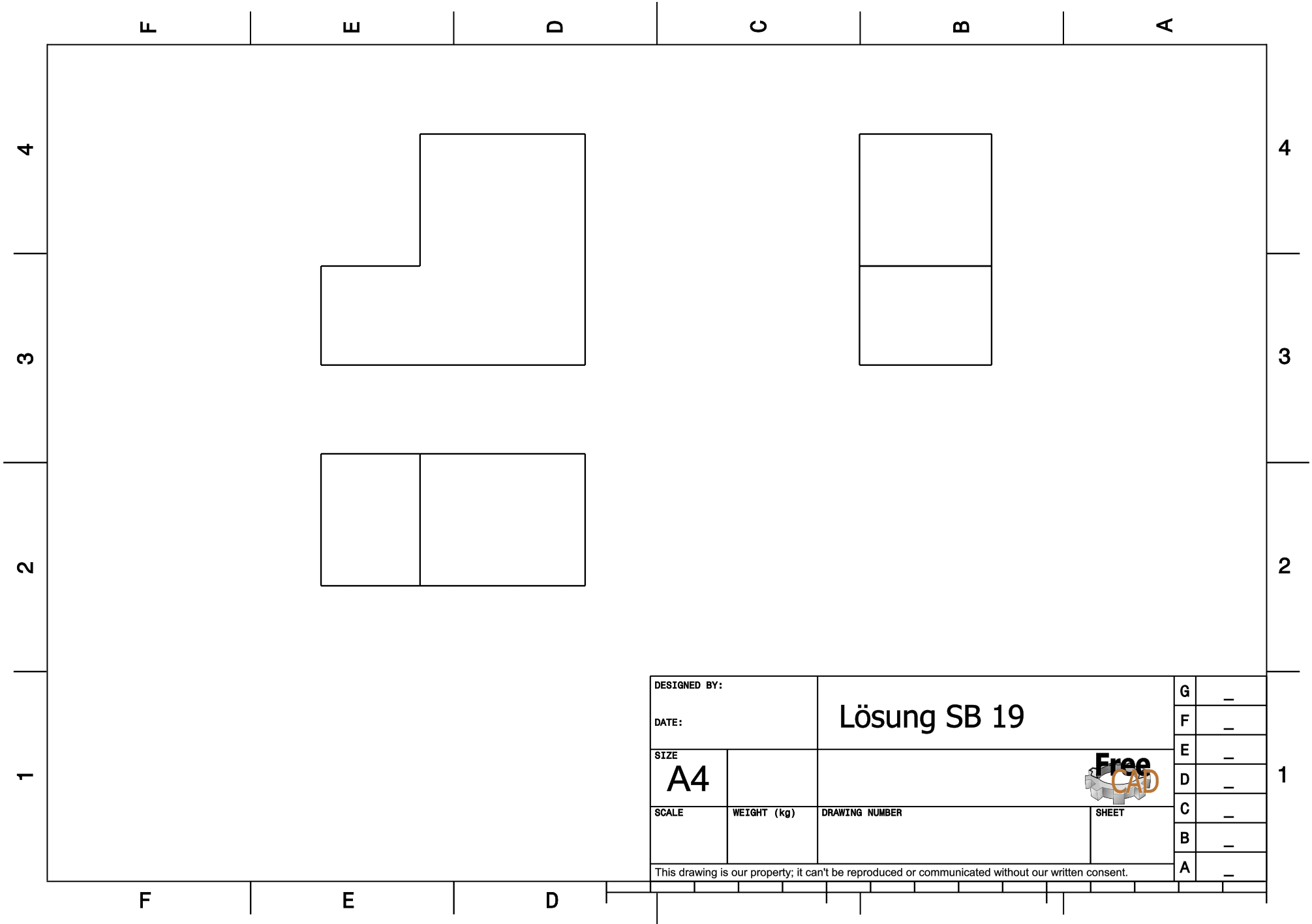

|   |                |   |   |   |   |
|---|----------------|---|---|---|---|
| DESIGNED BY:  |                | Lösung SB 18  |   | G | - |
| DATE:   |                |   |   | F | - |
| SIZE  | A4             |  |   | E | - |
| SCALE   |                |   |   | D | - |
| WEIGHT (kg)   | DRAWING NUMBER | SHEET   | C | - |   |
|   |                |   |   | B | - |
| This drawing is our property; it can't be reproduced or communicated without our written consent. |                |   |   | A | - |



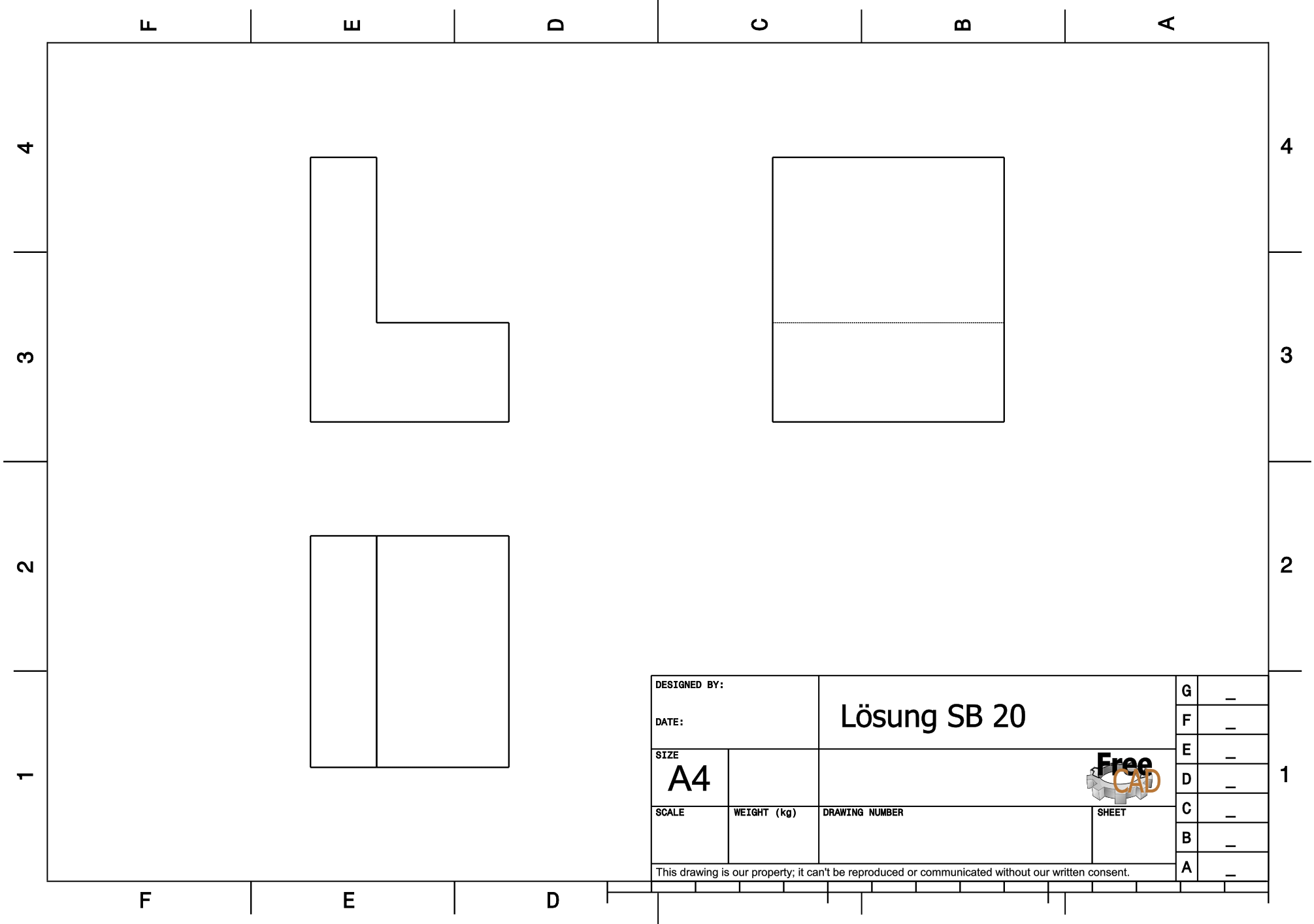

|   |                |   |   |   |   |
|---|----------------|---|---|---|---|
| DESIGNED BY:  |                | Lösung SB 19  |   | G | - |
| DATE:   |                |   |   | F | - |
| SIZE  | A4             |  |   | E | - |
| SCALE   |                |   |   | D | - |
| WEIGHT (kg)   | DRAWING NUMBER | SHEET   | C | - |   |
|   |                |   |   | B | - |
| This drawing is our property; it can't be reproduced or communicated without our written consent. |                |   |   | A | - |



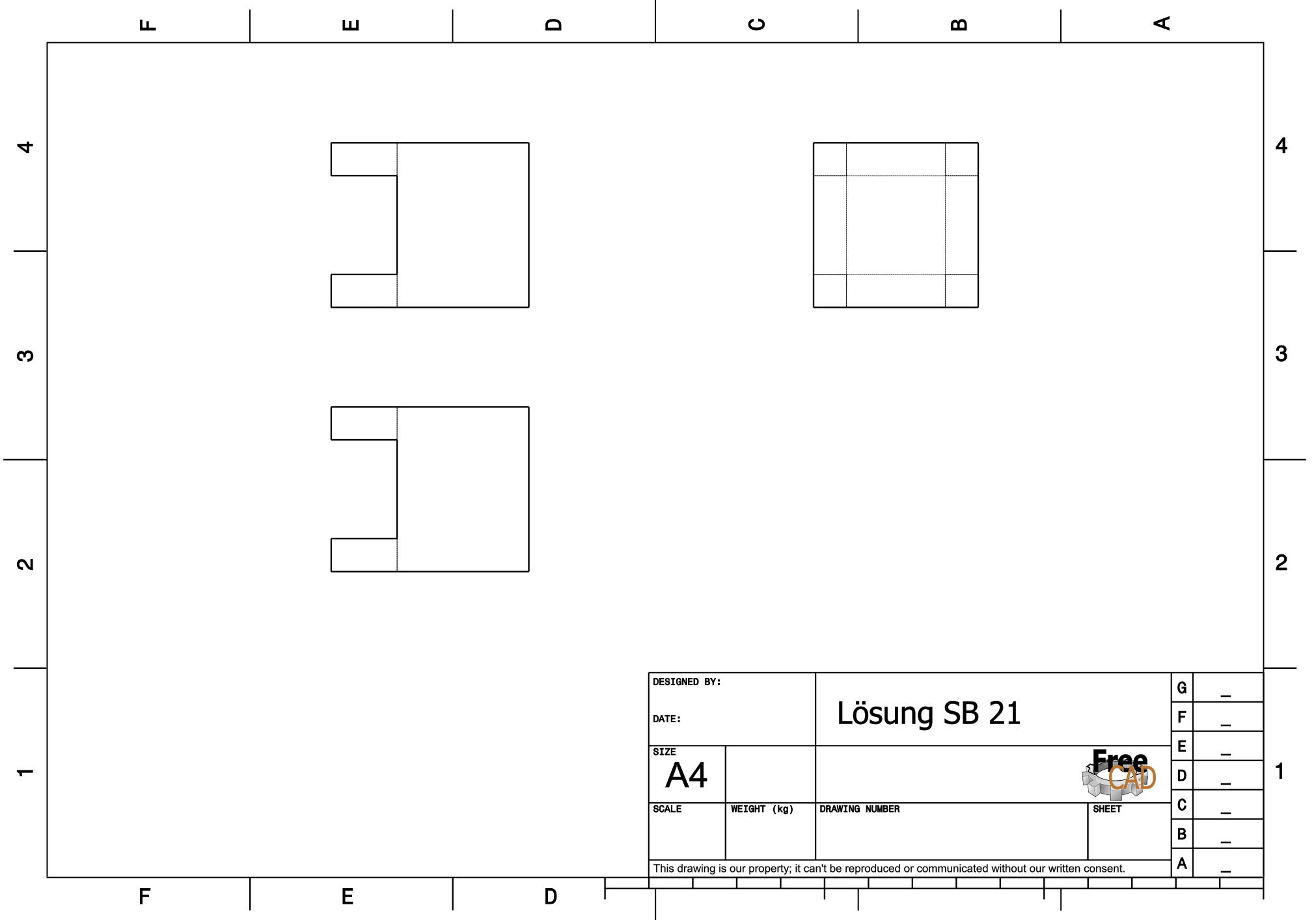

|   |    |                |  |             |       |
|---|----|----------------|--|-------------|-------|
| DESIGNED BY:  |    | Lösung SB 20   |  | G           | -     |
| DATE:   |    |                |  | F           | -     |
| SIZE  | A4 | DRAWING NUMBER |  | E           | -     |
| SCALE   |    |                |  | WEIGHT (kg) | SHEET |
|   |    |                |  | C           | -     |
|   |    |                |  | B           | -     |
| This drawing is our property; it can't be reproduced or communicated without our written consent. |    |                |  | A           | -     |



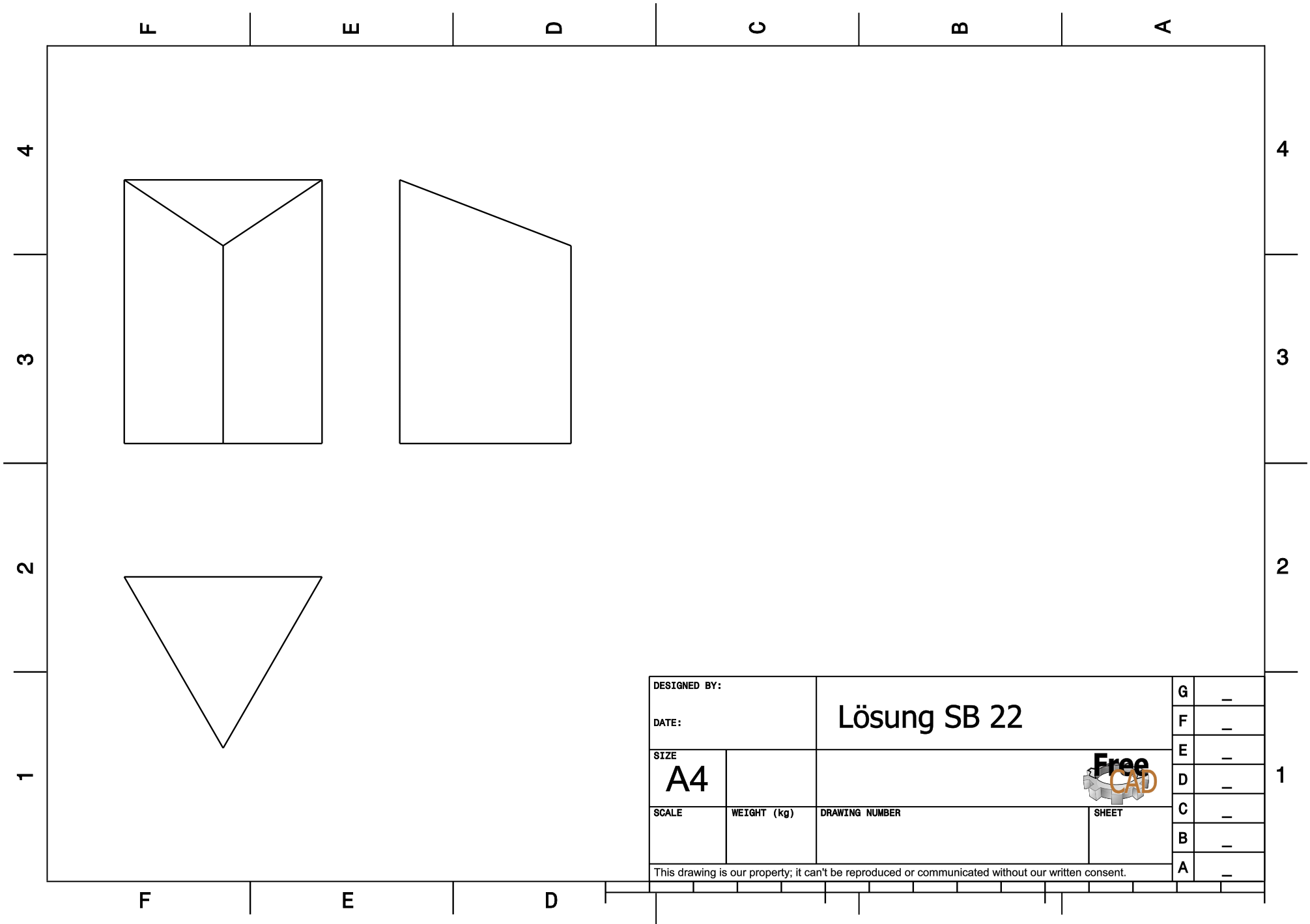

|   |             |   |  |                |       |
|---|-------------|---|--|----------------|-------|
| DESIGNED BY:  |             | Lösung SB 21  |  | G              | -     |
| DATE:   |             |   |  | F              | -     |
| SIZE  | A4          |  |  | E              | -     |
| SCALE   | WEIGHT (kg) |   |  | DRAWING NUMBER | SHEET |
|   |             |   |  | C              | -     |
|   |             |   |  | B              | -     |
| This drawing is our property; it can't be reproduced or communicated without our written consent. |             |   |  | A              | -     |



|   |                |   |  |   |   |
|---|----------------|---|--|---|---|
| DESIGNED BY:  |                | Lösung SB 22  |  | G | - |
| DATE:   |                |   |  | F | - |
| SIZE  | A4             |  |  | E | - |
| SCALE   |                |   |  | D | - |
| WEIGHT (kg)   | DRAWING NUMBER | SHEET   |  | C | - |
|   |                |   |  | B | - |
| This drawing is our property; it can't be reproduced or communicated without our written consent. |                |   |  | A | - |

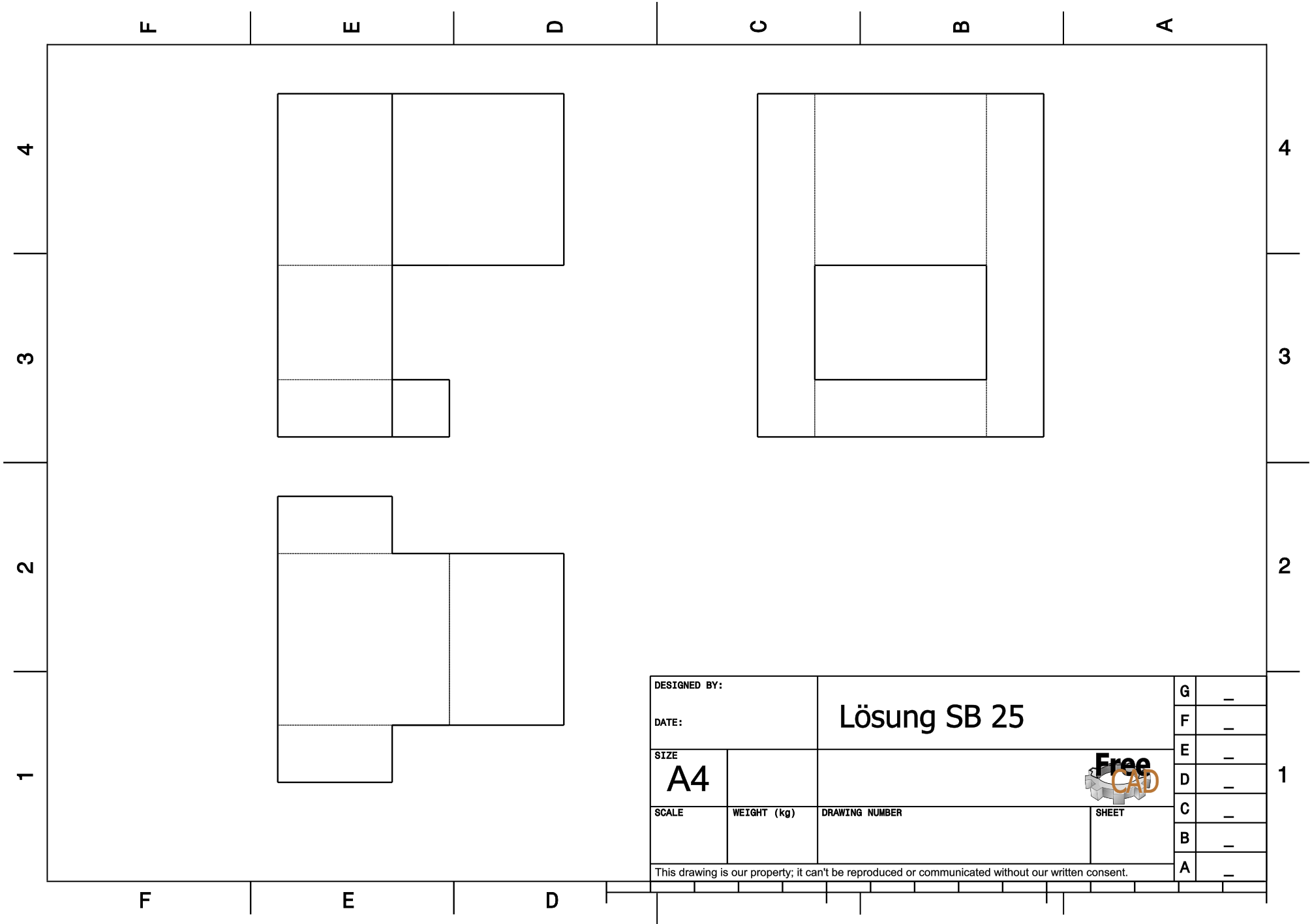

|   |    |              |  |             |                |
|---|----|--------------|--|-------------|----------------|
| DESIGNED BY:  |    | Lösung SB 25 |  | G           | -              |
| DATE:   |    |              |  | F           | -              |
| SIZE  | A4 |              |  | E           | -              |
| SCALE   |    |              |  | WEIGHT (kg) | DRAWING NUMBER |
|   |    |              |  | C           | -              |
|   |    |              |  | B           | -              |
| This drawing is our property; it can't be reproduced or communicated without our written consent. |    |              |  | A           | -              |



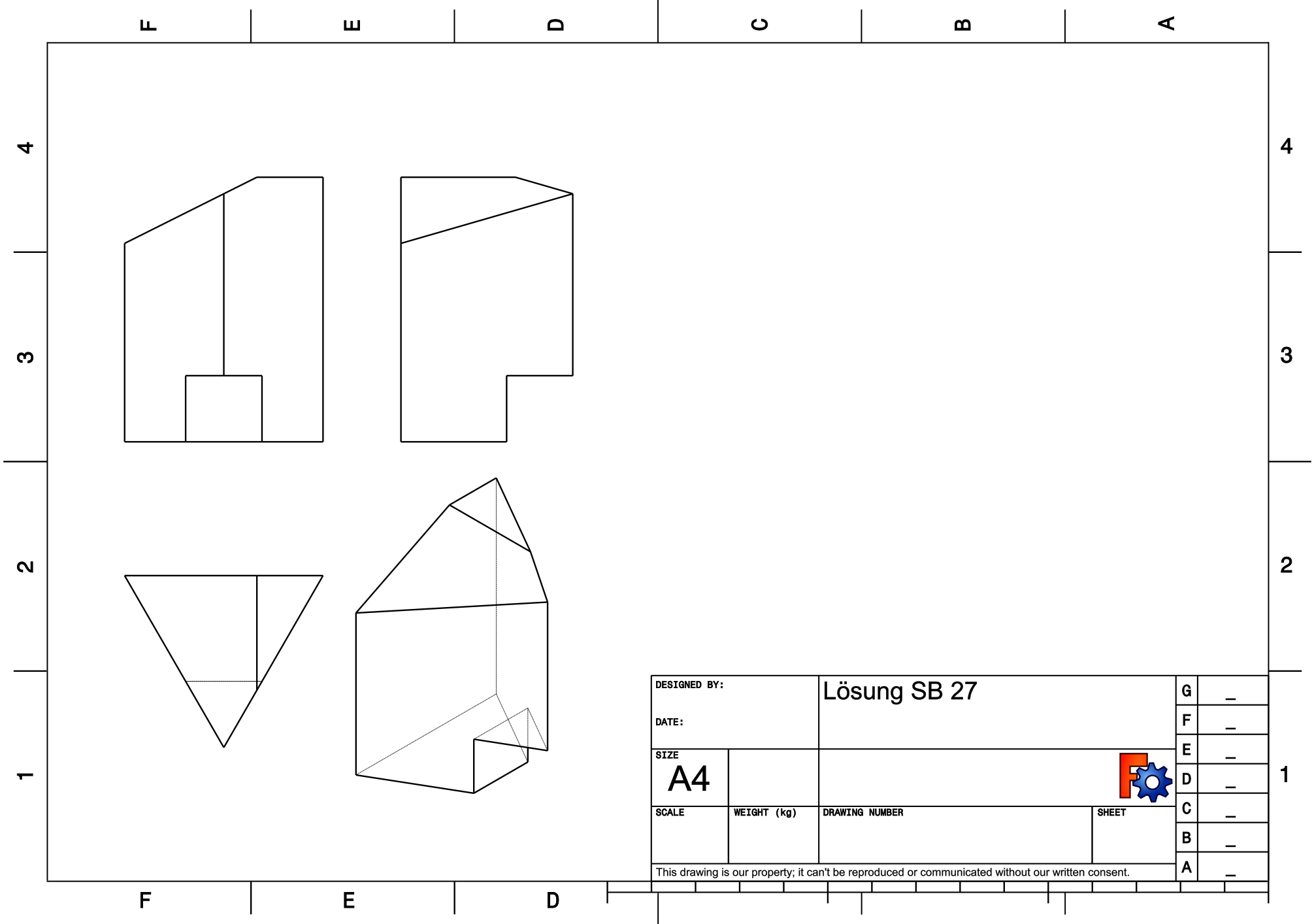

|   |             |                |       |   |   |
|---|-------------|----------------|-------|---|---|
| DESIGNED BY:  |             | Lösung SB 27   |       | G | - |
| DATE:   |             |                |       | F | - |
| SIZE  |             |                |       | E | - |
| <b>A4</b>   |             |                |       | D | - |
| SCALE   | WEIGHT (kg) | DRAWING NUMBER | SHEET | C | - |
|   |             |                |       | B | - |
| This drawing is our property; it can't be reproduced or communicated without our written consent. |             |                |       | A | - |



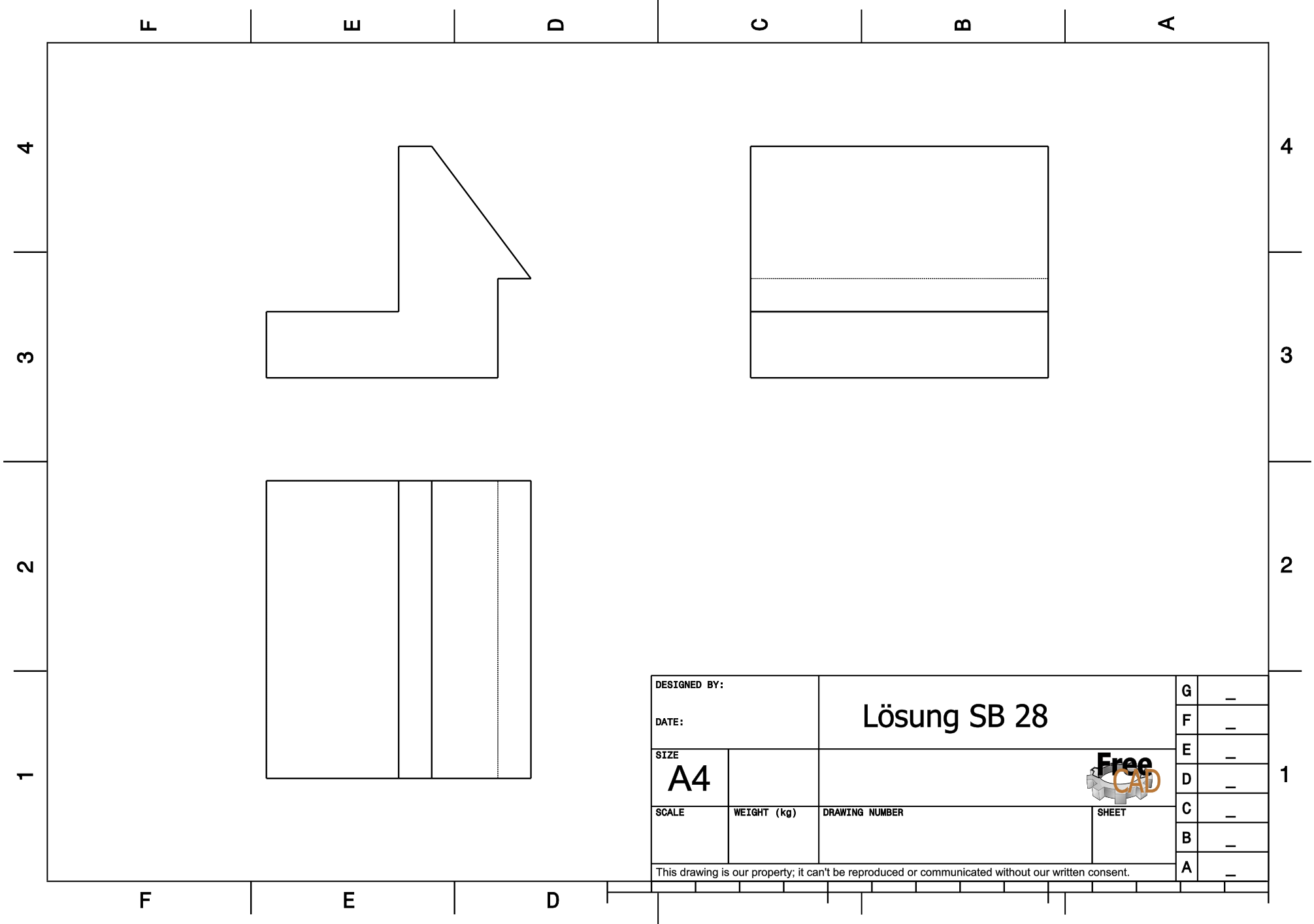

|              |                |              |   |   |   |
|--------------|----------------|--------------|---|---|---|
| DESIGNED BY: |                | Lösung SB 28 |   | G | - |
| DATE:        |                |              |   | F | - |
| SIZE         | A4             | Free CAD     |   | E | - |
| SCALE        |                |              |   | D | - |
| WEIGHT (kg)  | DRAWING NUMBER | C            | - |   |   |
|              |                | B            | - |   |   |
|              |                | A            | - |   |   |

This drawing is our property; it can't be reproduced or communicated without our written consent.

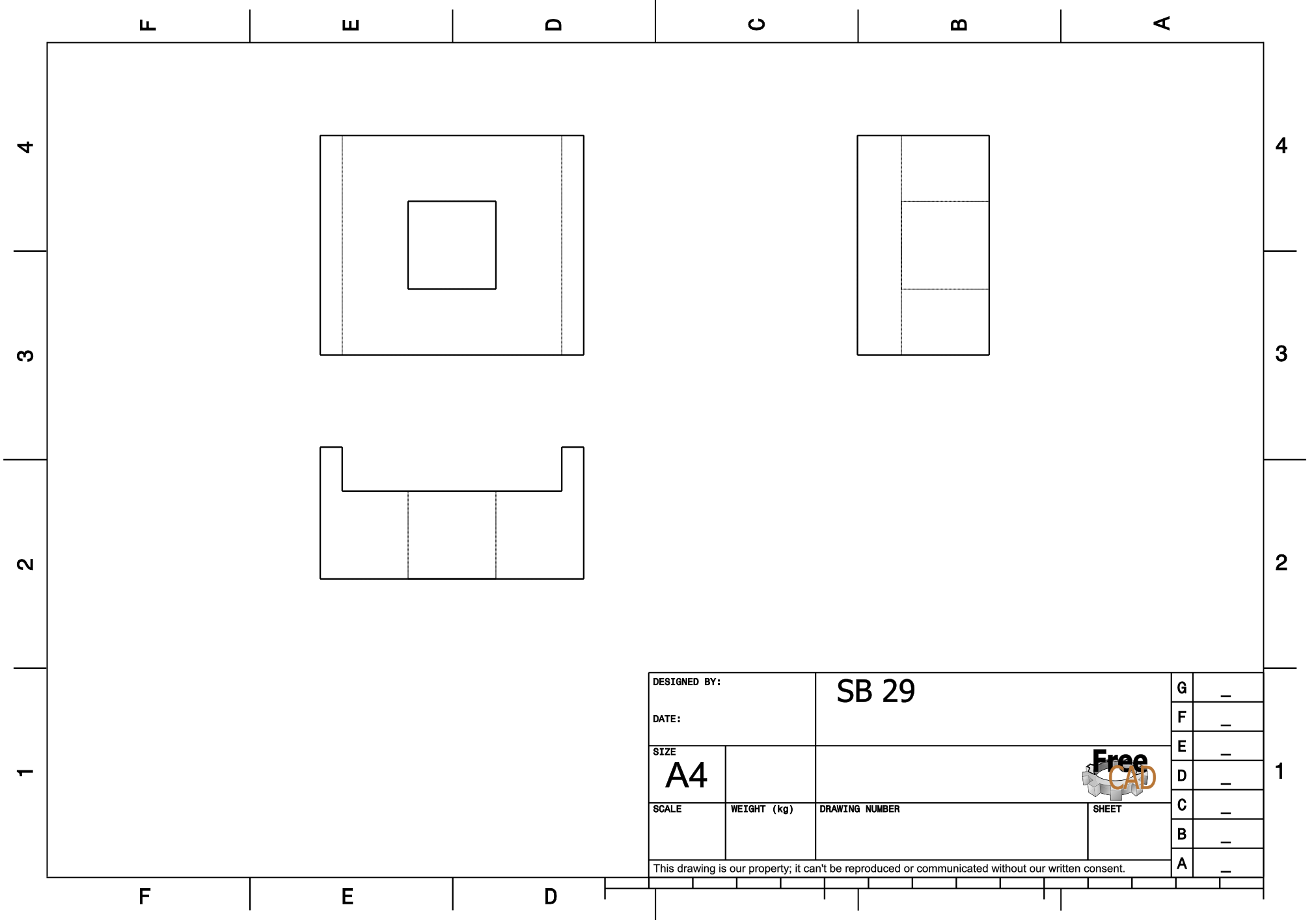

|   |             |                |       |   |   |
|---|-------------|----------------|-------|---|---|
| DESIGNED BY:  |             | SB 29          |       | G | - |
| DATE:   |             |                |       | F | - |
| SIZE  | A4          |                |       | E | - |
| SCALE   | WEIGHT (kg) | DRAWING NUMBER | SHEET | D | - |
|   |             |                |       | C | - |
|   |             |                |       | B | - |
| This drawing is our property; it can't be reproduced or communicated without our written consent. |             |                |       | A | - |



F E D C B A

4

3

2

1

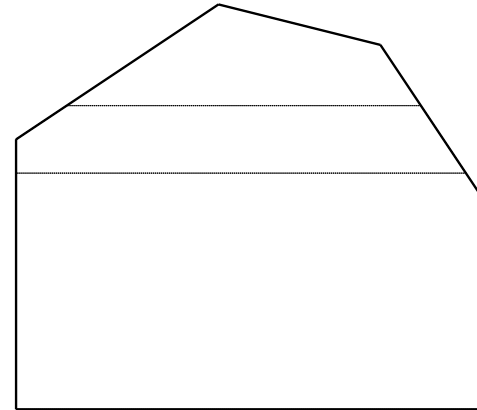
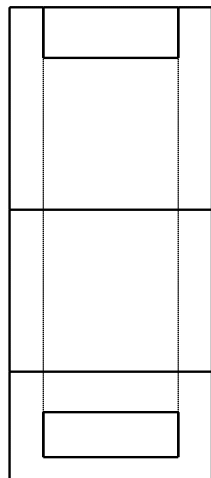
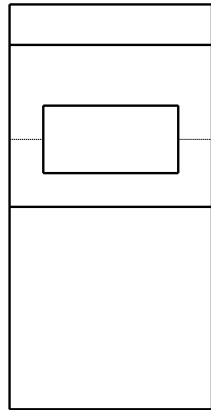

4

3

2

1

|              |                |              |   |   |   |
|--------------|----------------|--------------|---|---|---|
| DESIGNED BY: |                | Lösung SB 30 |   | G | - |
| DATE:        |                |              |   | F | - |
| SIZE         | A4             | Free CAD     |   | E | - |
| SCALE        |                |              |   | D | - |
| WEIGHT (kg)  | DRAWING NUMBER | C            | - |   |   |
|              |                | B            | - |   |   |
|              |                | A            | - |   |   |

This drawing is our property; it can't be reproduced or communicated without our written consent.

F E D

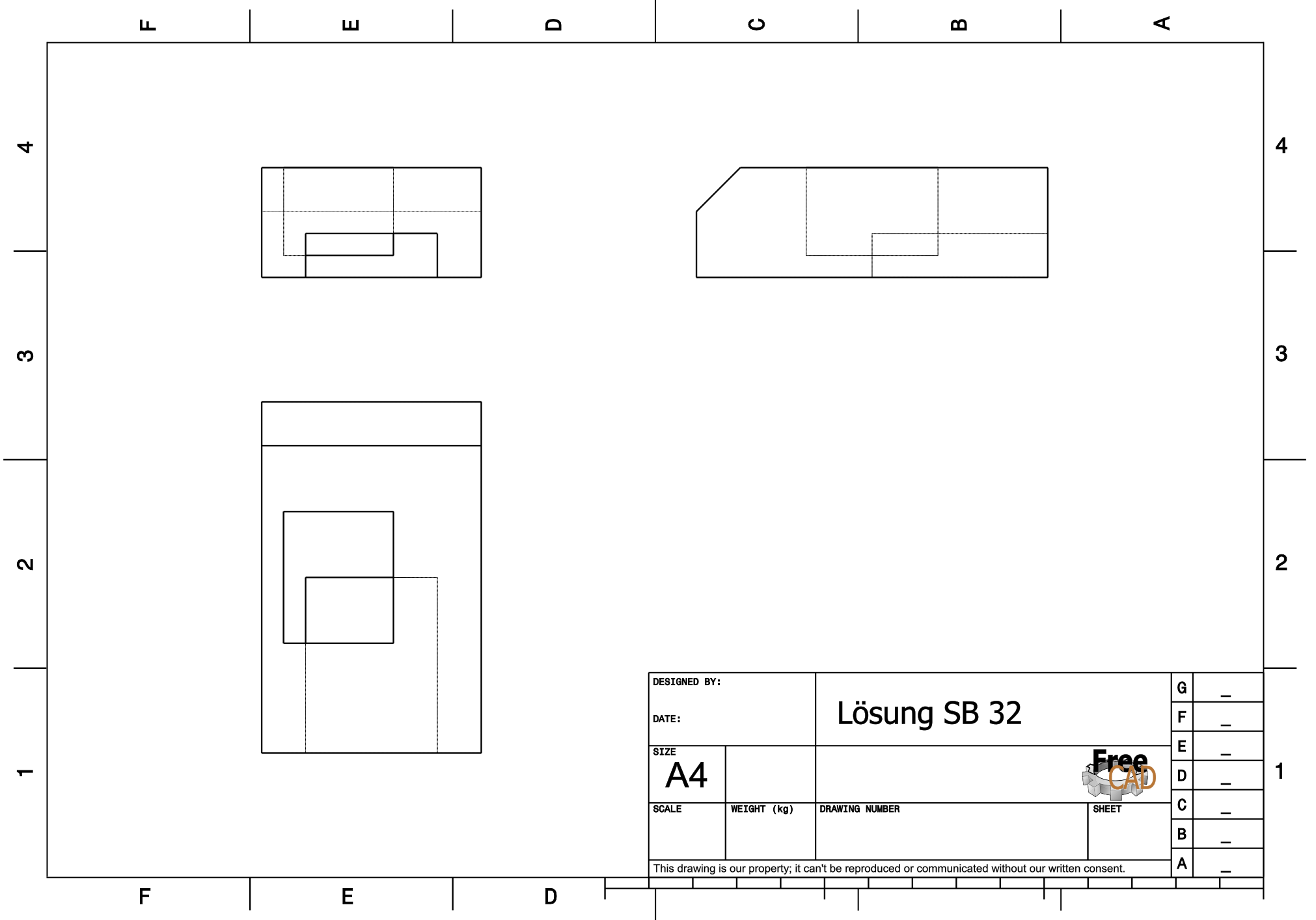

|   |                |   |   |   |   |
|---|----------------|---|---|---|---|
| DESIGNED BY:  |                | Lösung SB 32  |   | G | - |
| DATE:   |                |   |   | F | - |
| SIZE  | A4             |  |   | E | - |
| SCALE   |                |   |   | D | - |
| WEIGHT (kg)   | DRAWING NUMBER | SHEET   | C | - |   |
|   |                |   | B | - |   |
| This drawing is our property; it can't be reproduced or communicated without our written consent. |                |   |   | A | - |

F E D C B A

4  
3  
2  
1

4  
3  
2  
1

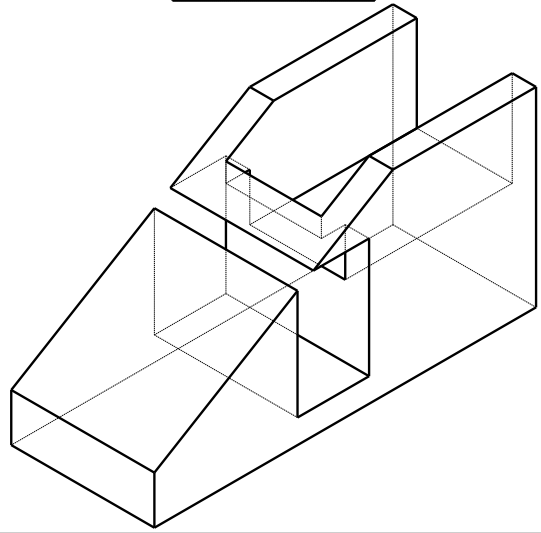
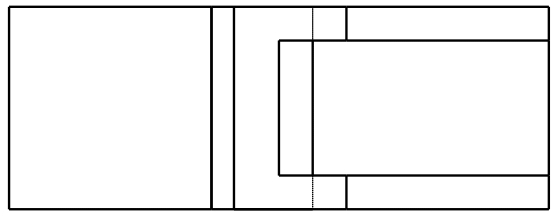
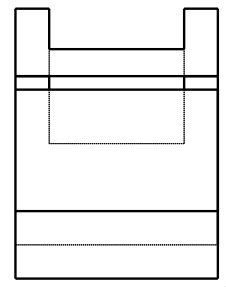
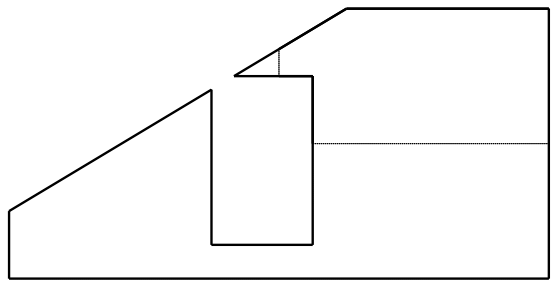

|   |             |                |       |   |   |
|---|-------------|----------------|-------|---|---|
| DESIGNED BY:  |             | Lösung SB 33   |       | G | - |
| DATE:   |             |                |       | F | - |
| SIZE  |             |                |       | E | - |
| A4  |             |                |       | D | - |
| SCALE   | WEIGHT (kg) | DRAWING NUMBER | SHEET | C | - |
|   |             |                |       | B | - |
| This drawing is our property; it can't be reproduced or communicated without our written consent. |             |                |       | A | - |



F E D